

33 815 682



- saillie 241 mm
- bec pivotant 360°
- en option, possibilité de limiter le pivotement avec un set de limitation de pivotement 12 820 970 90
- jet enrichi en air
- débit d'eau maxi. 6,3 l/min avec une pression d'écoulement de 3 bars
- sans plomb
- Ce produit contribue au respect des exigences des systèmes d'évaluation des bâtiments écologiques, par exemple LEED®, BREEAM®, DGNB

	Chrome	33 815 682-00
	Platine brossé	33 815 682-06
	Platine	33 815 682-08
	Laiton (Or 23cts)	33 815 682-09
	Dark Chrome	33 815 682-19
	Laiton brossé (Or 23cts)	33 815 682-28
	Noir mat	33 815 682-33
	Champagne brossé (Or 22cts)	33 815 682-46
	Champagne (Or 22cts)	33 815 682-47
	Chrome brossé	33 815 682-93
	Dark Platinum brossé	33 815 682-99

**Accessoires recommandés**

**Kit de limitation de pivotement - 12 820 970 90**



**Accessoires recommandés**

**Commande de vidage individuelle manuelle Commande manuelle - Chrome 10 712 970-00**



**Accessoires recommandés**

**Distributeur sans rosace - Chrome 82 424 970-00**



33 815 682

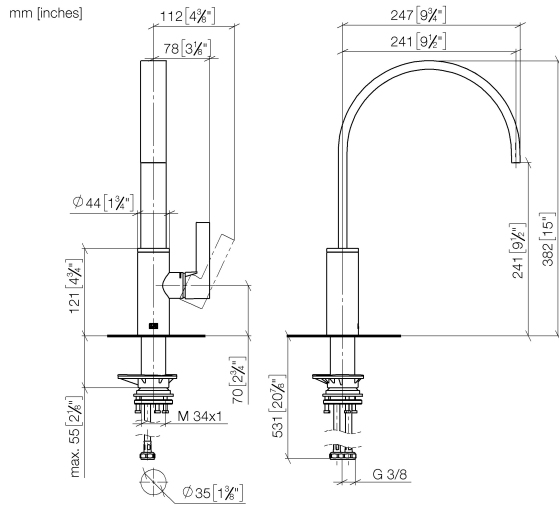

**Diagramme de débit**



**Certificats**

LGA\_38646.

WRAS\_240202021.

33 815 682

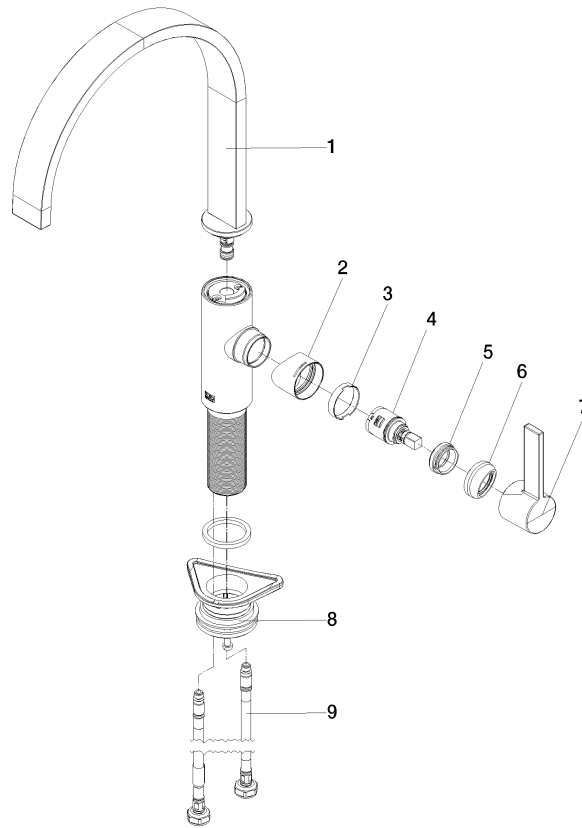

### Liste des pièces de rechange

N°	Article Numéro	Désignation	Fréquence de montage	Délai de livraison
1	90 28 22 333 00-00	bec déverseur	1	-
La pièce de rechange ne peut plus être commandée, veuillez commander l'article de remplacement				
2	09 19 86 012-00	hotte	1	60
3	90 23 10 128 00 90	écrou	1	2
4	90 15 05 042 00 90	cartouche	1	2
5	09 24 04 266 90	écrou	1	2
6	90 28 30 052 00-00	hotte	1	10
7	90 20 86 004 00-00	poignée	1	10
8	04 23 10 044 08 90	set de fixation	1	2
9	04 30 04 100 00 90	flexible	2	2